

SATELLITE METAL INC.

321 DESLAURIERS
 ST. LAURENT, QUÉBEC, CANADA H4N 1W4
 TELEPHONE: (514) 337-0955
 FAX: (514) 337-0491
 Toll Free 1-800-463-7667



SVI:satimp02466

SATELLITE METAL INC.

151 E. SEAMAN NECK RD.
 DIX HILLS, NY 11746-8118
 TEL: (631) 243-3088
 FAX: (631) 254-6629
 Toll Free 1-800-543-9058

© Satellite Metal Inc. – 2012 – All Rights Reserved

NOTES

Vertical & Horizontal Blind Hardware

Quincaillerie pour stores verticaux et horizontaux

Zubehör für Vertikal- und Horizontaljalousien

Ferretería para persianas verticales y horizontales

Ferramenta per veneziane verticali e orizzontali

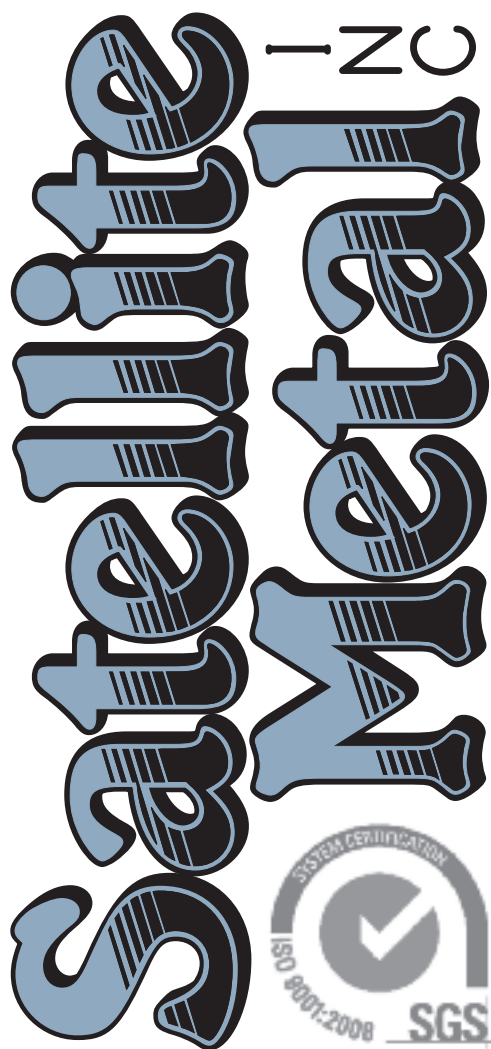

www.satellitemetal.com

* where applicable
 le cas échéant
 wo zutreffend
 Si es el caso
 Dove si può fissare

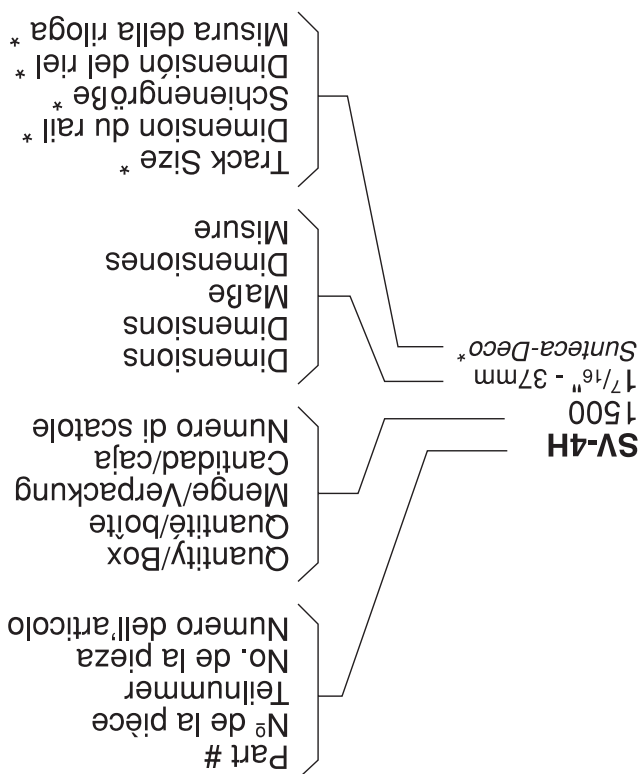

- Ⓒ How to interpret catalog information
- Ⓕ Interpretation des renseignements fournis dans le catalogue
- Ⓖ Erläuterungen der Kataloginformationen
- Ⓔ Interpretación de las informaciones suministradas en el catálogo
- Ⓘ Come leggere il catalogo

FASCIA BRACKETS 3" - With Holes

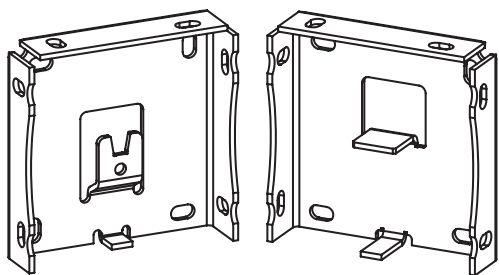

SRB-361-4H 50 Sets (R-8)
SRB-362-4H 50 Sets (R-8)
SRB-561-4H 50 Sets (R-16)

FASCIA BRACKETS 4" - With Holes

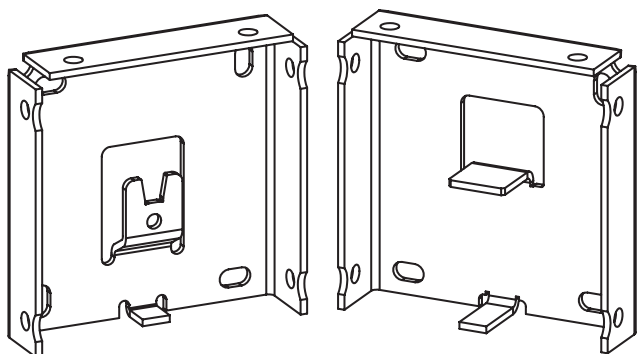

SRB-581-4H
 25 Sets
 (R-24)



Also available with retainer clip
 (specify)

Available in White, Vanilla, Grey, Bronze and Black
 Disponible en blanc, ivoire, gris, bronze et noir
 Verfügbar in weiß, elfenbein, grau, bronze und schwarz
 Disponible en blanco, marfil, gris, bronce o annerire
 Disponibili in bianco, avorio, gris, bronce e negro

(GB)	Vane Savers	2
	Hangers	3
	Snap-On Clips	4
I	Wall Brackets & Wall Bracket Assemblies	5-10
N	Extension Brackets	11
D	Vane Weights & Sew-In Weights	12
E	Spacer Link & Woven Wood Brackets	13
X	Horizontal Blind Components	14-18
	Wood Valance Brackets	19
	Pleated Shade Weights	20
	Roller Blind Hardware	21-24

(F)	Sauve-lamelles	2
	Barrettes	3
	Supports de plafond	4
I	Supports muraux & ensembles de support	5-10
N	Supports de rallonge	11
D	Poids ordinaires et à coudre	12
E	Tige d'espacement & supports pour bois	13
X	Pièces pour stores horizontaux	14-18
	Supports pour cantonnière en bois	19
	Poids pour stores plissés	20
	Pièces pour stores rouleaux	21-24

(D)	Lamellenschützer	2
	Haken	3
	Druck-Clips	4
I	Wandhalter & Wandhalterungen	5-10
N	Verlängerung der Halter	11
H	Lamellen- und eingenähte Gewichte	12
A	Verbindungsstück & Holz Halter	13
L	Horizontale Jalousienkomponenten	14-18
T	Halterungen für Holzschmuckleisten	19
	Plissierte Jalousien Gewichte	20
	Rolladen Installationsmaterial	21-24

(E)	Salvalistonea	2
	Espigas	3
I	Soportes de techo	4
N	Soportes murales & Conjuntos de soporte	5-10
D	Soportes de prolongación	11
E	Pesas ordinarias y para coser	12
	Varilla de espaciamento	13
	Piezas para persianas horizontales	14-18
	Supporti per sbalza in legno	19
	Pesas de la Persianas plegables	20
	Piezas para montura de cortina	21-24

(I)	Salvalamelle	2
	Sbarrette di sostegno	3
I	Sostegni da soffitto	4
N	Sostegni murali & sostegni accoppiati	5-10
D	Prolunghe per sostegni	11
E	Pesi per lamelle e pesi incorporati	12
	Aste di distanziamento	13
	Elementi di veneziane orizzontali	14-18
	Soportes para cenefa de madera	19
	Pesi par tendine pieghettate	20
	Ferramenta per avvolgibile	21-24

Roller Shade Brackets

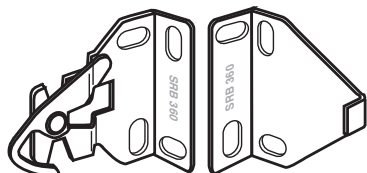

SRB-360
 100 Sets
 (R-8)

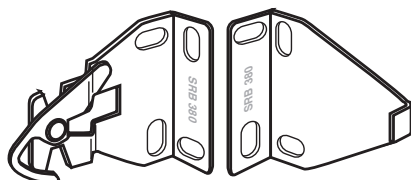

SRB-380
 100 Sets
 (R-8)

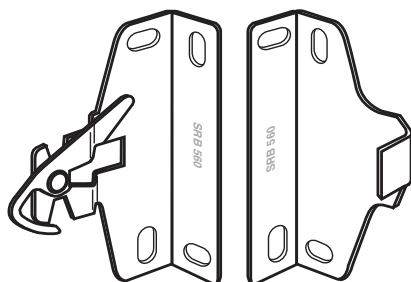

SRB-560
 100 Sets
 (R-16)

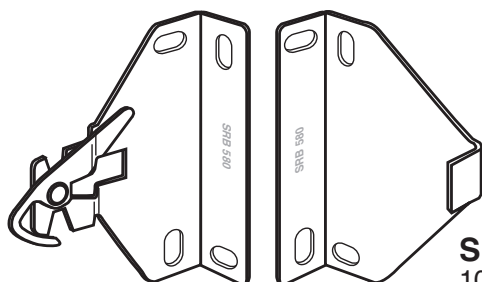

SRB-580
 100 Sets
 (R-16 & R-24)

Also available in Stainless Steel

Available in White, Black and Zinc Plated
 Disponible en blanc, noir ou galvanisé
 Verfügbar in weiß, schwarz und mit Zinkauflage
 Disponible en blanco, annerire o galvanizado
 Disponibili in bianco, negro e placcato zinco

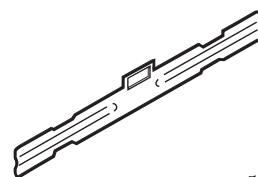

SV-1A
 5000
 3.5" - 89mm

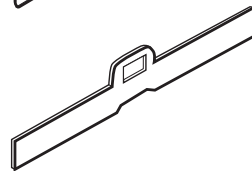

SV-1B
 5000
 3.5" - 89mm

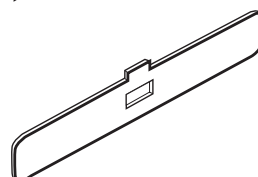

SV-1C
 4000
 3.5" - 89mm

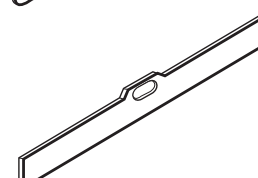

SV-1D
 4000
 3.5" - 89mm

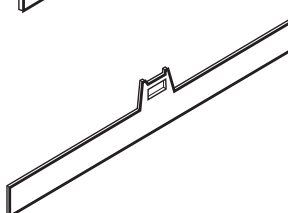

SV-1E
 2000
 5" - 127mm



SV-1F
 1000
 2 lb / 900g

Angled Blind Hook

Crochet pour stores cathédrale

Haken für Giebelfensterjalousien

Gancho para persianas de formas irregulares

Gancio per veneziane (formato irregolare)

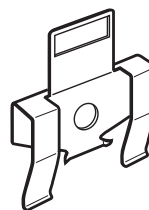

SV-1G
 500
 4 lb / 1.8kg

Vertical Blind Wood Slat Clip

Store vertical, fixation pour latte de bois

Verticaljalousie, Klemmhalter für Holzleisten

Tenda verticale, clip di fissaggio per lamelle in legno

Persianna vertical, presilla para tablilla de madera

VANE SAVER™*

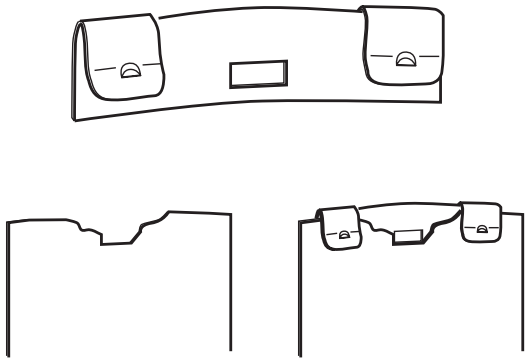

VANE SAVER PLUS™*

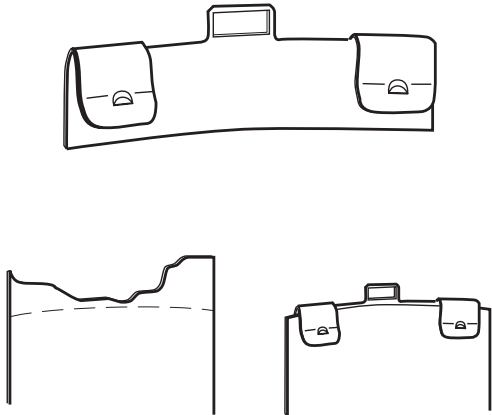

Available in White, Ivory and Zinc Plated
 Flat or curved – 100/box
 Disponible en blanc, ivoire ou galvanisé
 Plat ou courbé – 100/boîte
 Verfügbar in weiß, elfenbein und mit Zinkauflage
 Flach oder gebogen – 100/Packung
 Disponible en blanco, marfil o galvanizado
 Plano o curvado – 100/caja
 Disponibili in bianco, avorio e placcato zinco
 Piatta o curvata – 100/scatola

FASCIA BRACKETS 3"

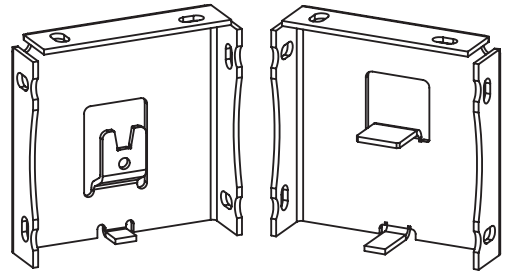

SRB-361 50 Sets (R-8)
SRB-362 50 Sets (R-8)
SRB-561 50 Sets (R-16)

FASCIA BRACKETS 4"

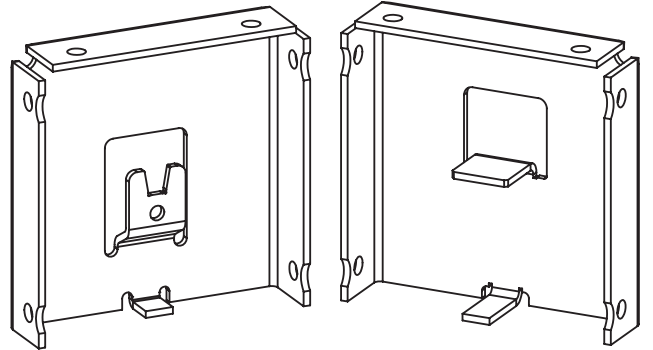

SRB-581
 25 Sets (R-24)



Also available with retainer clip (specify)

Available in White, Vanilla, Grey, Bronze and Black
 Disponible en blanc, ivoire, gris, bronze et noir
 Verfügbar in weiß, elfenbein, grau, bronze und schwarz
 Disponible en blanco, marfil, grigio, bronzo o annerire
 Disponibili in bianco, avorio, gris, bronzo e negro



SV-4A
 2000
 1.5" – 40mm

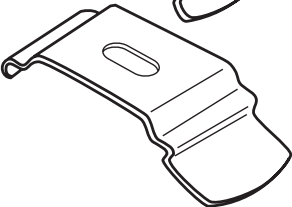

SV-4AL
 1500
 1.5" – 40mm

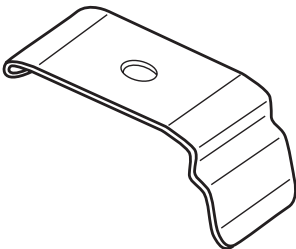

SV-4B 1500 1⁵/₈" – 41mm

SV-4C 1500 1.5" – 40mm

SV-4D 2500 1¹/₁₆" – 27mm

SV-4E 1500 1.7" – 43mm

SV-4H 1500 1⁷/₁₆" – 37mm
 Sunteca-Deco

SV-4K 2500 1⁵/₃₂" – 29mm
 Faber

SV-4N 1500 1¹³/₁₆" – 46mm
 Faber

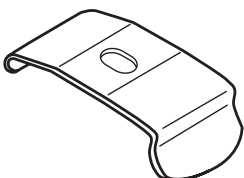

SV-4F
 2000
 1³/₈" – 35mm
 Graber Lite

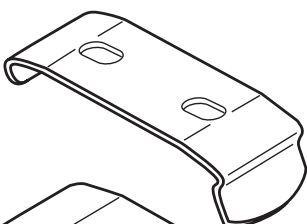

SV-4G
 1500
 1¹⁵/₁₆" – 49mm
 G71 - Graber

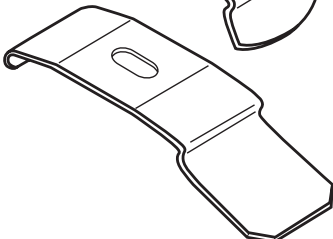

SV-4J
 1500
 1.5" – 40mm
 Profile

Roller Blind Hardware

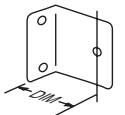
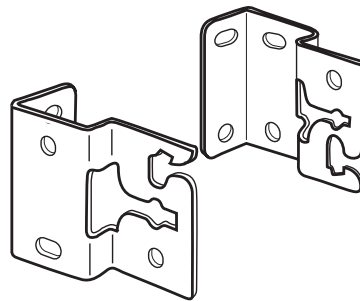

R110
 500
 1³/₁₆" - 30.2mm

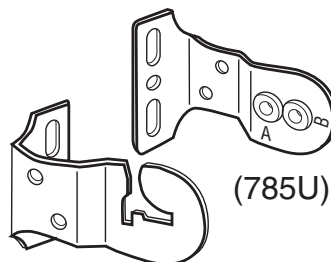

R111
 900
 1⁵/₁₆" - 33.3mm

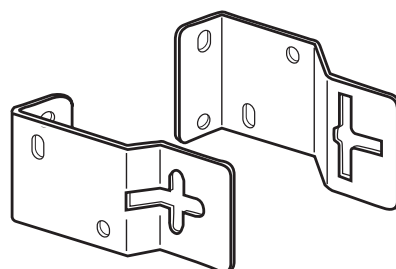

R-8
 750
 1⁵/₁₆" - 33.3mm

R-16
 600
 1⁵/₈" - 41.3mm

R-24
 500
 2¹/₁₆" - 52.3mm

Pleated Shade Weights



SPS-3/4" x 3T
150
Hunter Douglas
COMFORTEX

SPS-3/4" x 4T
150
Hunter Douglas
COMFORTEX

SPS-3/4" x 5T
150
Hunter Douglas
COMFORTEX

SPS-3/4" x 6T
75
Hunter Douglas
COMFORTEX

SPS-3/4" x 8T
75
Hunter Douglas
COMFORTEX

SPS-3/4" x 10T
75
Hunter Douglas
COMFORTEX

SPS-3/4" x 12T
75
Hunter Douglas
COMFORTEX

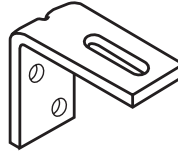

SV-28
500
1 5/8" – 40mm

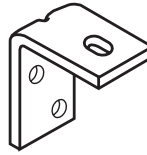

SV-28N
500
1 1/4" – 32mm

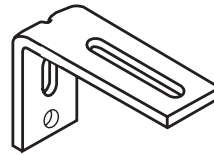

SV-29
500
2 1/8" – 54mm

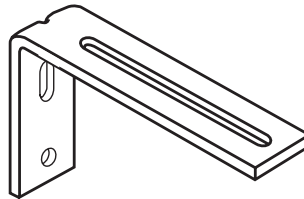

SV-30
350
3 3/8" – 85mm

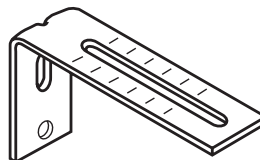

SV-32
500
2 7/8" – 73mm

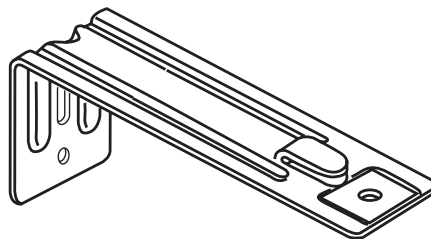

SV-53
250
4" – 100mm

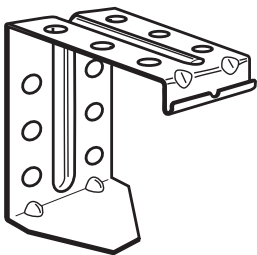

SH-9004A
200
14 lb / 6.3kg

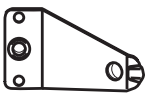

SH-9005-15
1000
18 lb / 8.2kg

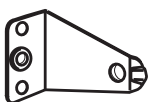

SH-9005-90
1000
18 lb / 8.2kg

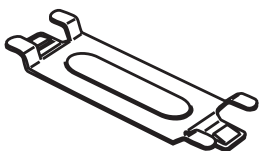

SH-9006
1000
13 lb / 5.9kg

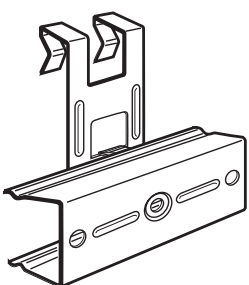

SH-9007
500 Sets
14 lb / 6.3kg

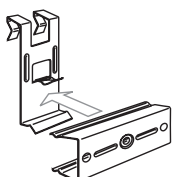

SV-50
350
2 7/8" – 73mm

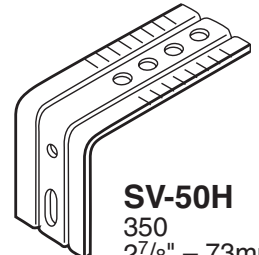

SV-50H
350
2 7/8" – 73mm

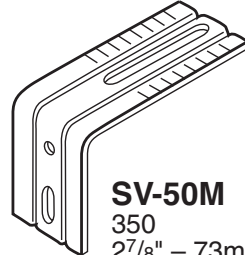

SV-50M
350
2 7/8" – 73mm

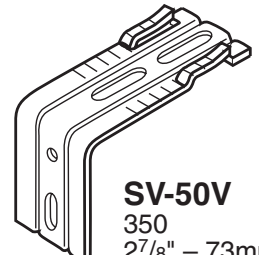

SV-50V
350
2 7/8" – 73mm

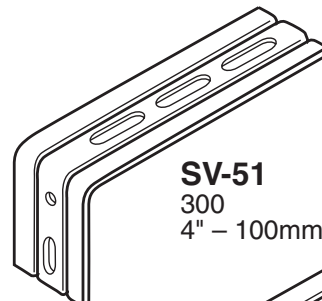

SV-51
300
4" – 100mm

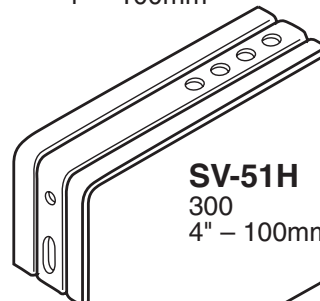

SV-51H
300
4" – 100mm

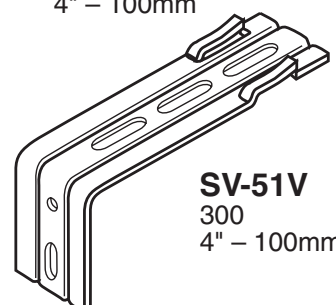

SV-51V
300
4" – 100mm

SV-65
150
8" - 200mm

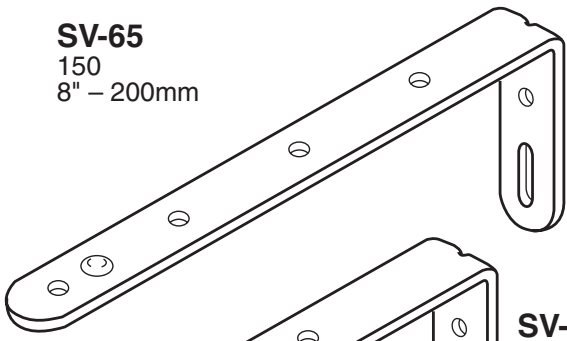

SV-64
250
6" - 150mm

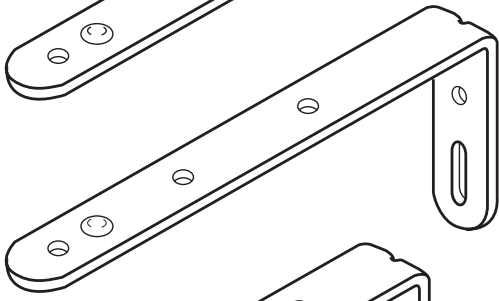

SV-63
200
5" - 125mm

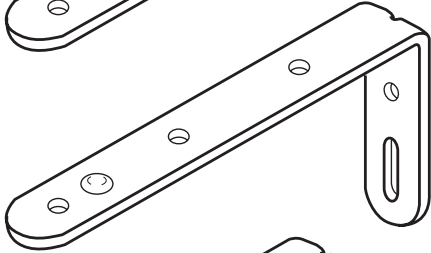

SV-62
250
4" - 100mm

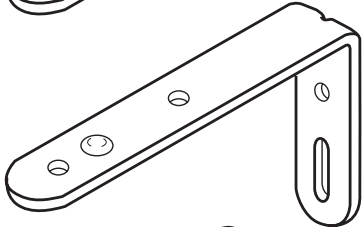

SV-61
350
3" - 75mm

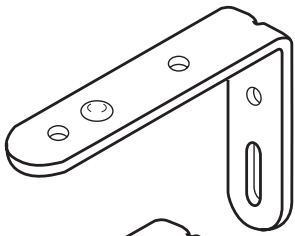

SV-60
500
2" - 50mm

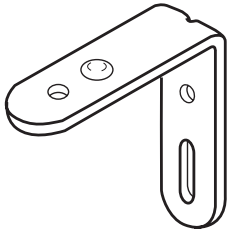

Wood Valance Corners

VAL-800
2500
25 lb / 11.3kg



VAL-810
500
22 lb / 10kg



VAL-820
500
24 lb / 10.9kg

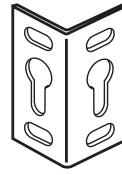

VAL-830
500
45 lb / 20.4kg

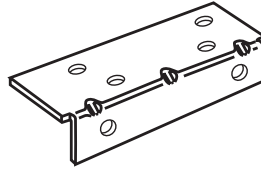

VAL-840
2000
28 lb / 12.7kg

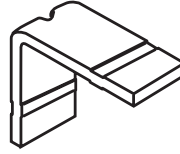

VAL-850
1000
23 lb / 10.4kg

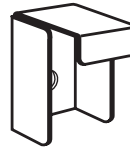

E-53
1000
40 lb / 18kg

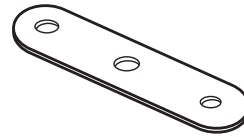

VAL-870
300
15 lb / 6.8kg

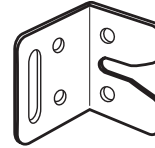

VAL-870L
250
25 lb / 11.4kg

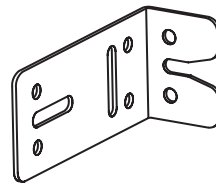

SV-5D
400
2³/₄" - 70mm

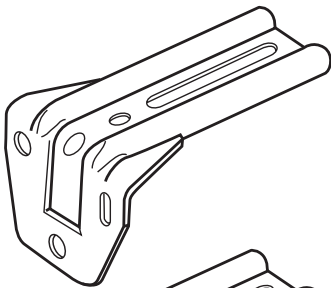

SV-5DH
400
2³/₄" - 70mm

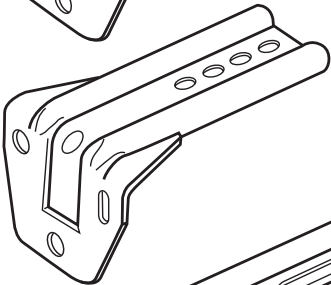

SV-5E
300
4" - 100mm

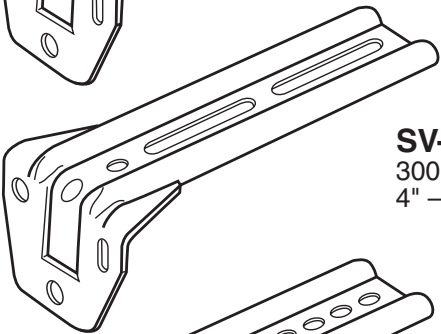

SV-5EH
300
4" - 100mm

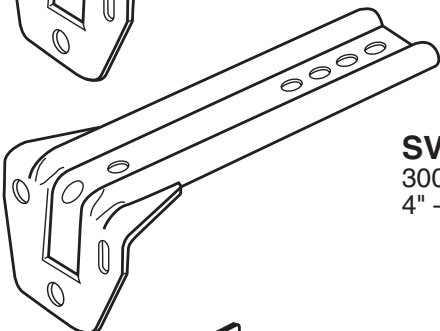

SV-31A
1000
1³/₄" - 45mm

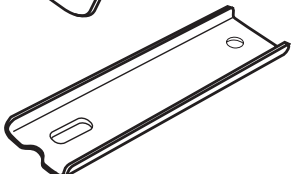

SV-5A
500
2¹/₂" - 64mm

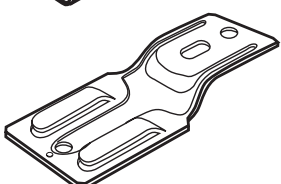

SH-9001-20
400
18 lb / 8.2kg

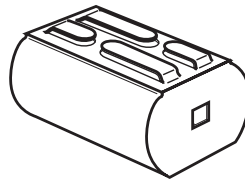

SH-9001-25
400
18 lb / 8.2kg

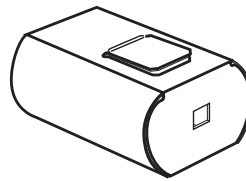

SH-9002
1000
18 lb / 8.2kg

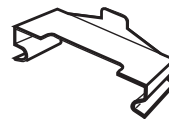

SH-9004
200
20 lb / 9.1kg

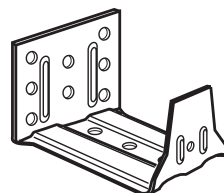

Components for 2" Low Profile

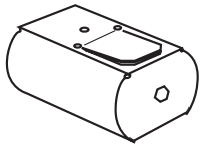

SH-8001
600
17 lb / 7.7kg

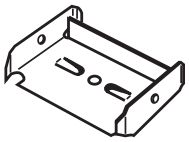

SH-8002
500
17 lb / 7.7kg

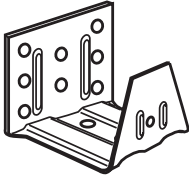

SH-8004
250
23 lb / 10.4kg

Components for 2" Head Rails

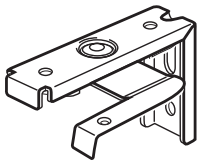

SH-9000
250
32 lb / 14.5kg

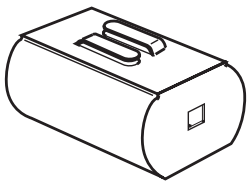

SH-9001-10
400
18 lb / 8.2kg

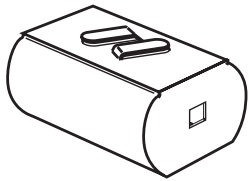

SH-9001-15
400
18 lb / 8.2kg

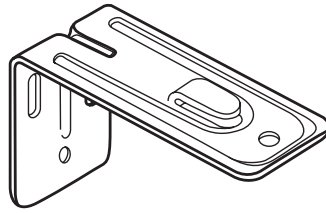

SV-5
350
2.8" - 71mm

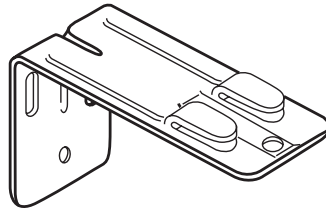

SV-5B
350
2.8" - 71mm

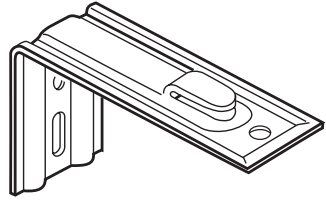

SV-5C
350
2.8" - 71mm

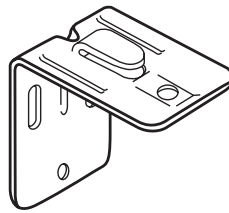

SV-7
500
1⁵/₈" - 41mm

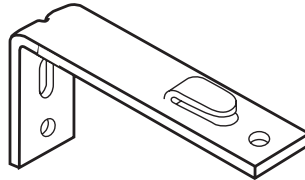

SV-36
400
2.8" - 71mm

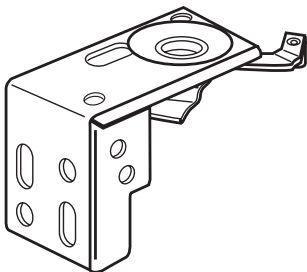

SH-10
500
1" - 25mm

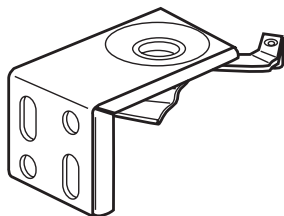

SH-15
500
1" - 25mm

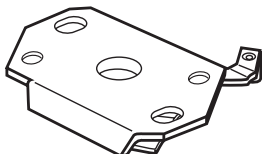

SH-20
1000
1" - 25mm

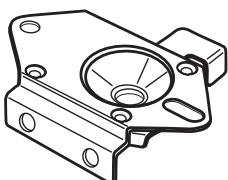

SH-25
500
1" x 1" (25 x 25mm)

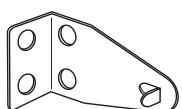

SH-30
500
1" - Micro

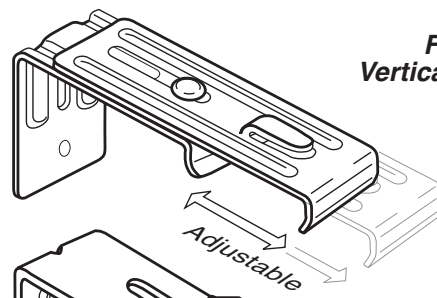

Fits ALL Vertical Head Rails

SV-52
100 per Box
1¹/₈" - 1¹⁵/₁₆"
(27 - 50mm)

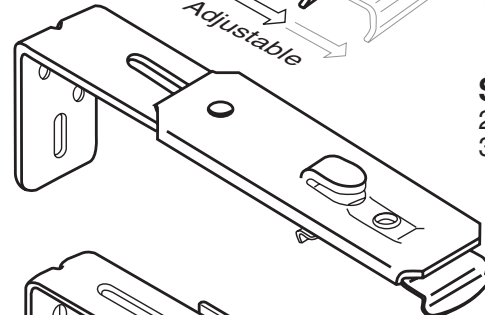

SV-9
200
3.5 - 5"
90 - 125mm

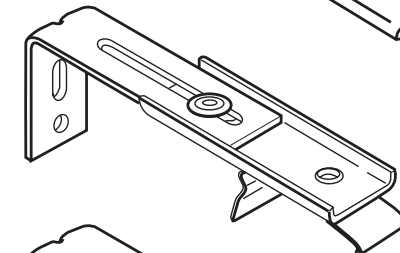

SV-92-29
250
2⁷/₈ - 3⁷/₈"
73 - 98mm

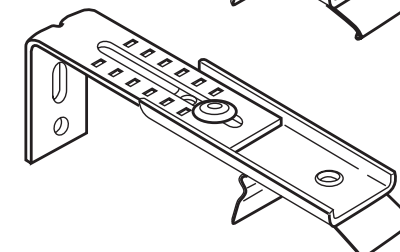

SV-92-30
200
4 - 5"
100 - 125mm

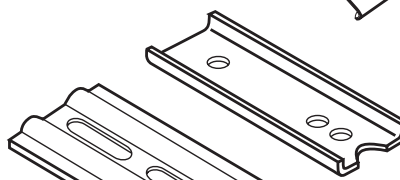

SV-92-32
200
3¹/₄ - 4¹/₂"
83 - 115mm

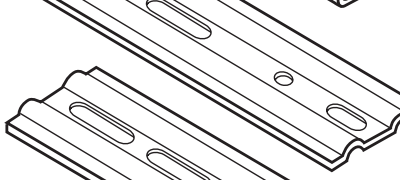

SV-31
1000
1⁷/₈" - 48mm

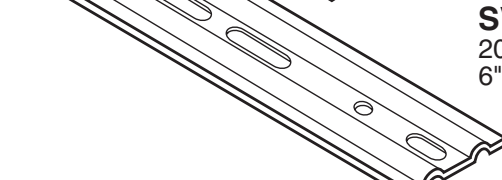

SV-50-A
250
4¹/₂" - 115mm



SV-51-A
200
6" - 150mm

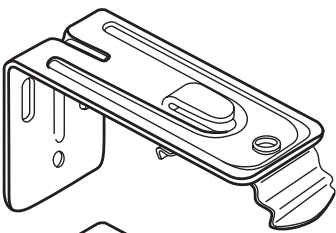

SV-6
250
2.8" – 71mm

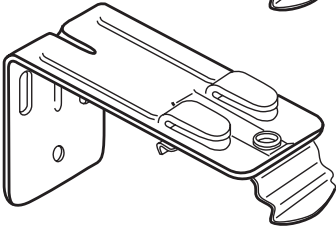

SV-6B
250
2.8" – 71mm

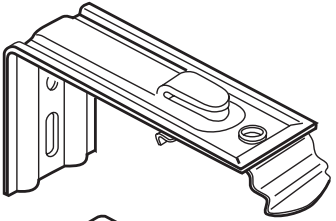

SV-6C
250
2.8" - 71mm

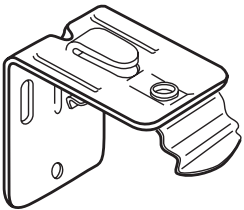

SV-8
400
1⁵/₈" - 41mm

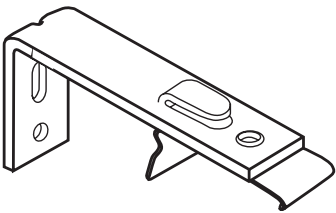

SV-40
400
2.8" – 71mm

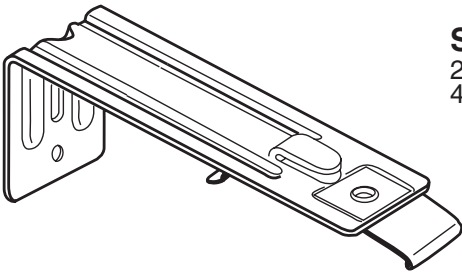

SV-53+Clip
200
4" – 100mm

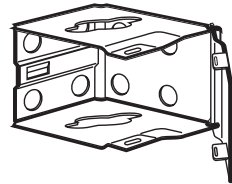

SH-40
50 pairs
3/4" x 1" – 19 x 27mm

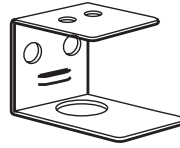

SH-70
1000
3/4" x 1" – 19 x 27mm

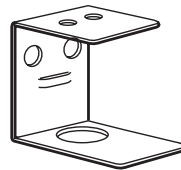

SH-72
1000
1" x 1" – 25 x 25mm

Specify **Quantity** and **Color** when ordering.
Préciser la **Quantité** et la **Couleur** au moment de la commande.
Bitte bei Bestellung **Menge** und **Farbe** angeben.
Precisar la **Cantidad** y el **Color** al hacer el pedido.
Precisare **Quantità** e **Colori** nell'ordinazione.

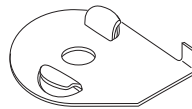

SH-4CLS
500 per Box
20 lb/M

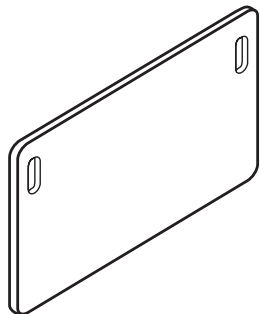

SV-10
250
0.074 x 3¹/₂" – 1.8 x 89mm

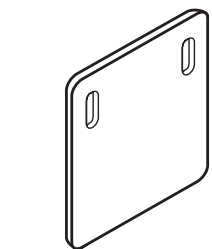

SV-10X
250
0.060 x 3¹/₂" – 1.5 x 89mm

SV-11
200
0.074 x 4" – 1.8 x 101mm

SV-11A
150
0.074 x 5" – 1.8 x 127mm

SV-14
500
0.074 x 2" – 1.8 x 50mm

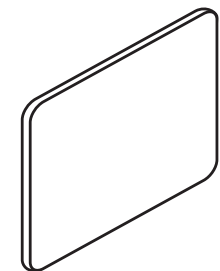

SV-18
300
0.074 x 2 x 2¹/₂
1.8 x 50 x 64mm

SV-18X
300
0.060 x 2 x 2³/₄
1.5 x 50 x 70mm

SV-18Y
250
0.074 x 2 x 2³/₄
1.8 x 50 x 70mm

SV-19
250
0.074 x 2 x 3¹/₂
1.8 x 50 x 89mm

SV-19X
150
0.074 x 2 x 4¹/₂
1.8 x 50 x 115mm

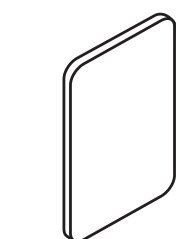

SV-20
500
1³/₈ x 2" – 35 x 50mm

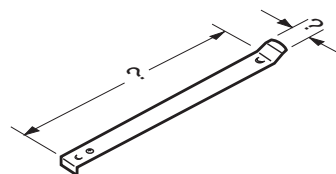

SV-27
1000
0.008" – 0.2mm
A = 5/16" - 7.95mm

SV-27-1/4
1000
0.008" – 0.2mm
A = 1/4" - 6.35mm

Woven Wood Brackets

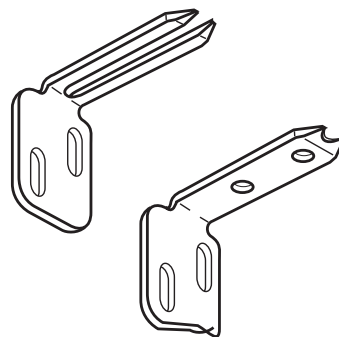

SW-2000
1000
44 lb / 20kg

SW-2000H
1000
44 lb / 20kg

Roman Shade Cord Clips

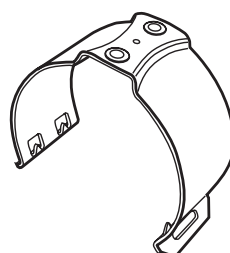

CF-1125
1000
1¹/₈" Tube

CF-1250
1000
1¹/₄" Tube

CF-1500
1000
1¹/₂" Tube

CF-2000
1000
2" Tube